

Cabaña STAR

Cabane Star

Star boomhut

Star treehouse bed



MATHYBYBOLS

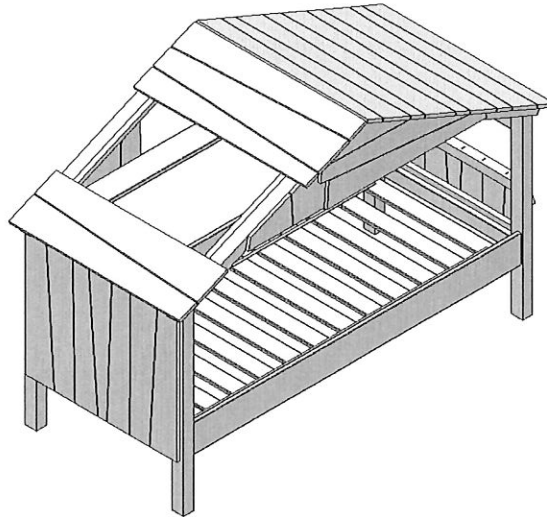

<p>Colis 1</p> <p>2X</p>	<p>Colis 2</p>	<p>Colis 3</p>
<p>Colis 4</p> <p>4X</p>	<p>Colis 5</p>	<p>Colis 6</p>
<p>Colis 7</p>	<p>Colis 8</p> <p>2X</p>	<p>Colis 9</p>
<p>1x n°5</p> <p>4x 14x110</p> <p>33x 4 x 50</p> <p>4x 3,5 x 25</p> <p>2x 14x110</p> <p>4x 4x50</p>		



1

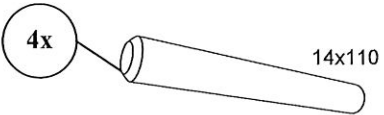
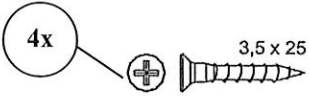
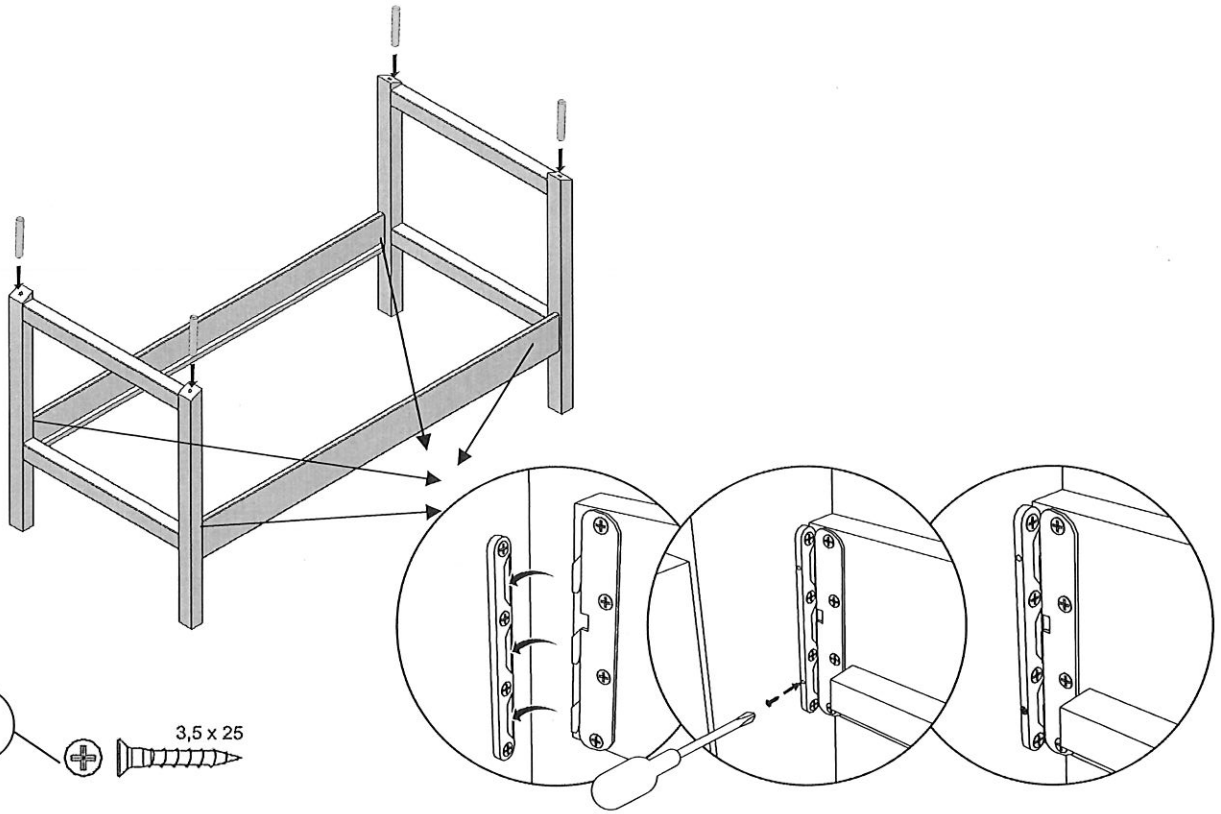

2

2

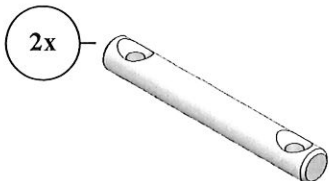
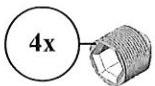
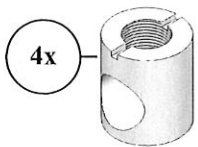
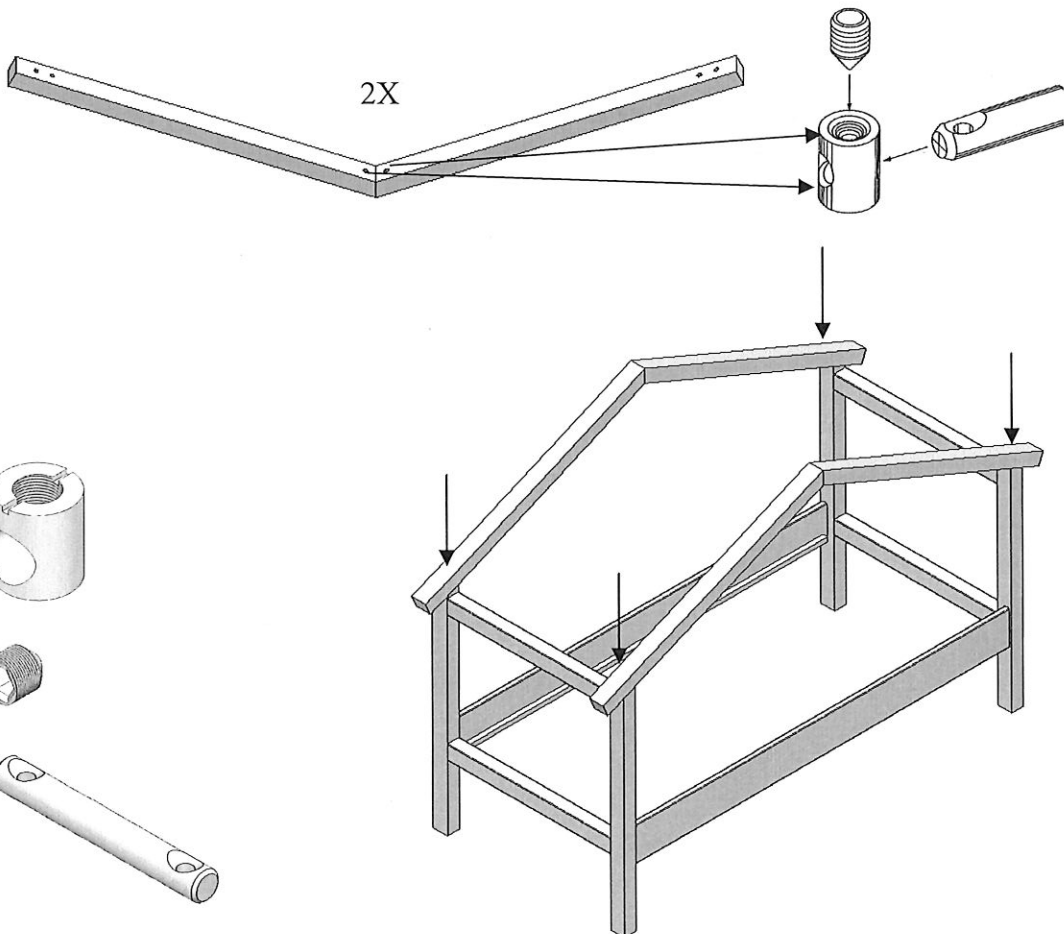



3

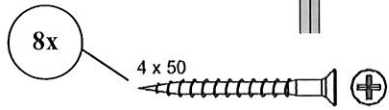
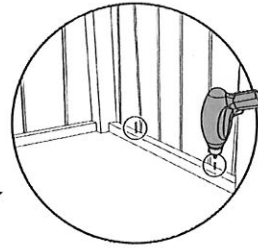
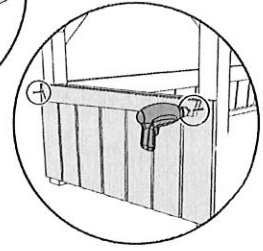
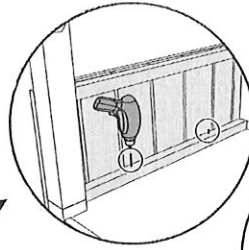
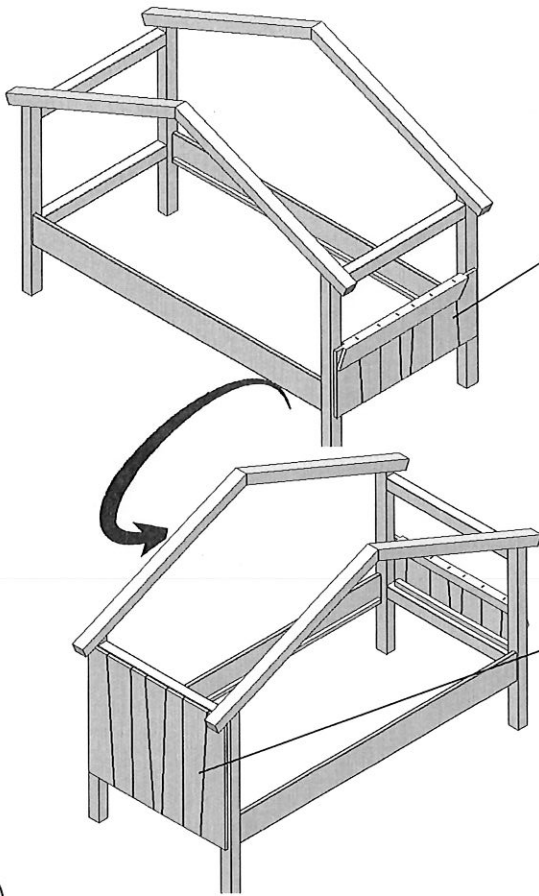

4

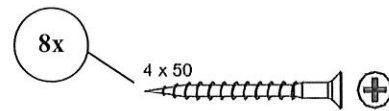
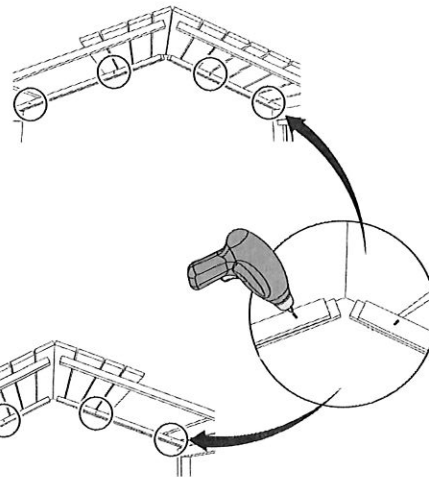
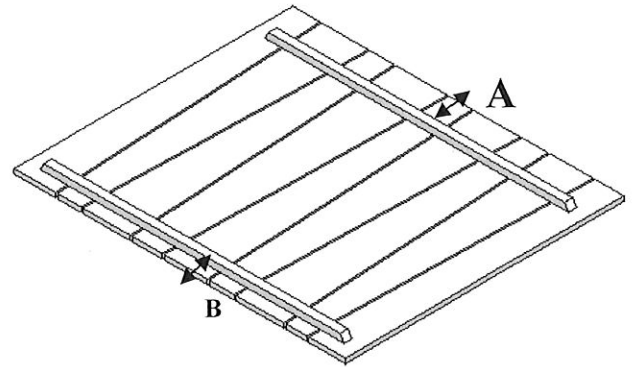
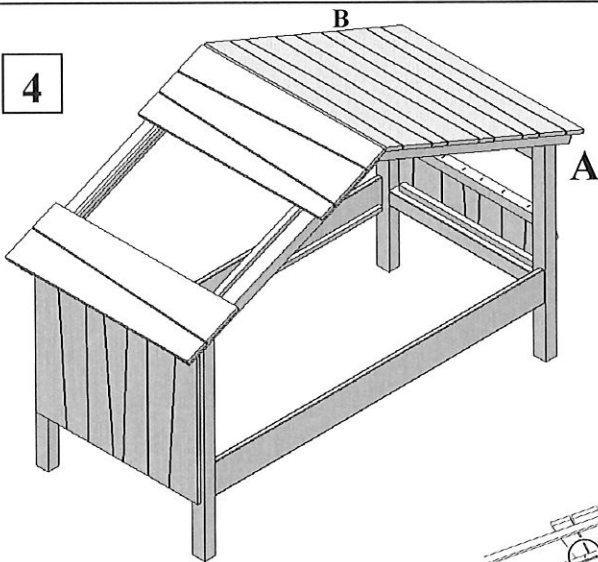



5

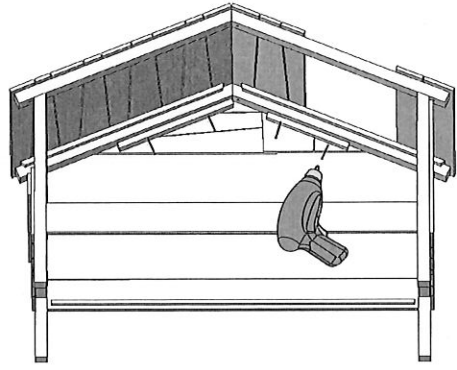
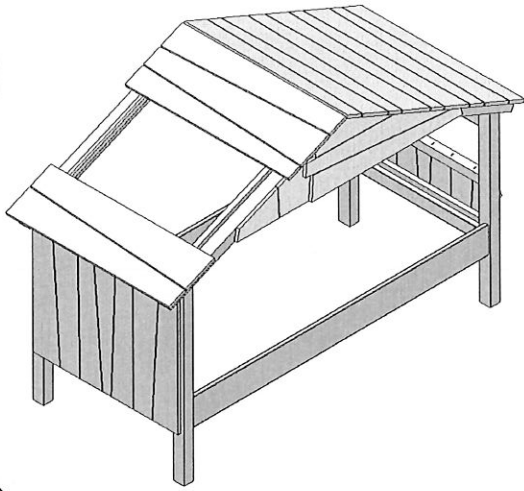

4x

4 x 50



6

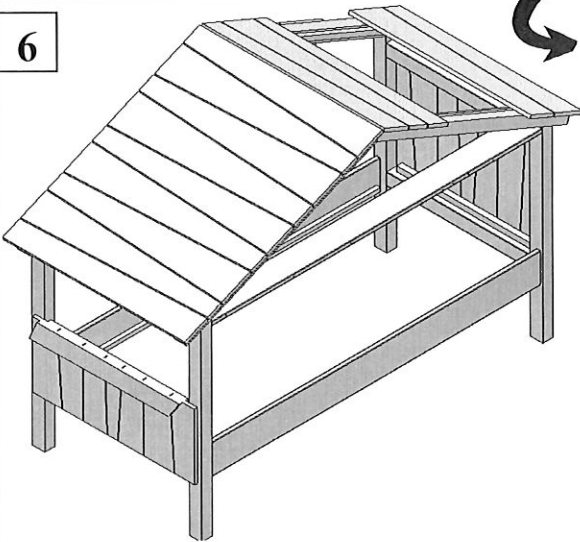

4

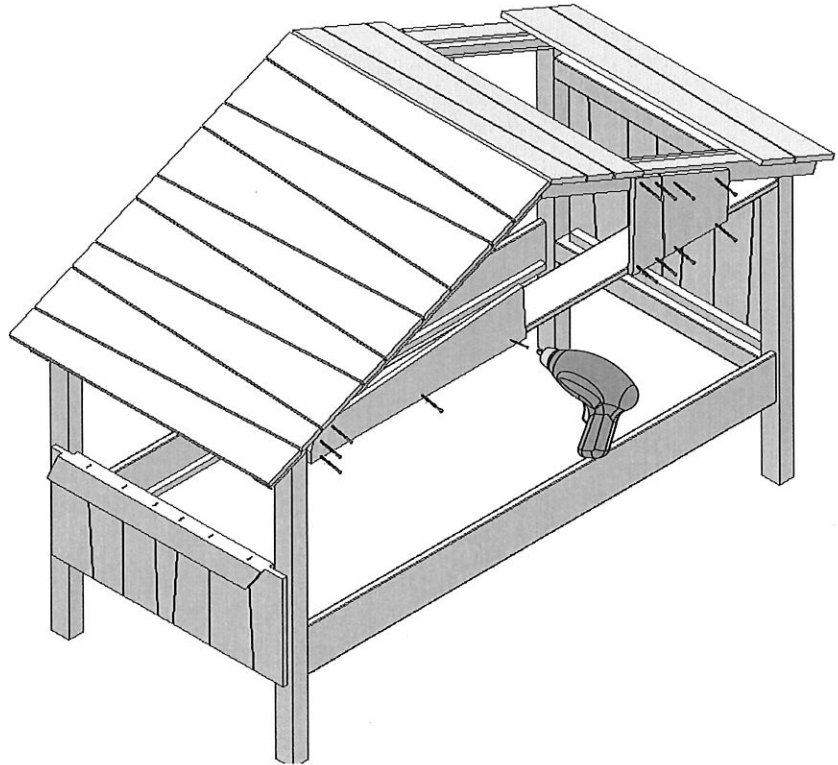

13x

4 x 50

